



KLAY-INSTRUMENTS

**PRODUCT
OVERVIEW**



**"ALL STAINLESS"
PRESSURE AND LEVEL
TRANSMITTERS**

About KLAY Instruments



- 

Page 4 and 5
Selection Guide
Klay Pressure transmitters
- 

Page 6 and 7
Series 8000 - Analogue
Pressure transmitters
- 

Page 8 and 9
Series 2000 - Intelligent
Pressure and Level transmitters
- 

Page 10 and 11
Series 4000 - Intelligent
Pressure and Level transmitters
- 

Page 12 and 13
DP-4000 - Intelligent
Differential pressure transmitters
- 

Page 14 and 15
Submersible Level transmitters
Hydrobar, HydroCer, AquaCer
- 

Page 16 and 17
- Special transmitters
- Series 3000 Ceramic Sensor
- 

Page 18 and 19
- Temperature transmitters
- Level Switches
- 

Page 20
Klay Instruments
World Wide

Klay Instruments is a Dutch manufacturer of All Stainless Steel Process Instrumentation. Founded in 1978 Klay has built up a long history in development, production and sales of Process Instrumentation. Our company is **ISO 9001-2015 certified**.

We produce a wide range of Pressure and Level transmitters in “**All Stainless Steel design**”, both Analog and “Intelligent” series are available with HART® Protocol and Profibus PA. Many certificates are available, like ATEX Ex, IECEx, SIL2, EHEDG and 3A food approvals, Marine Type approvals like DNV, BV, Lloyds, ABS and CCS. All industrial process connections are available (more than 90!).

Always a Stainless Steel Electronics housing !



Besides our pressure and level transmitters we also manufacture level switches, like our All Stainless Steel “Tuning fork” level switch type “Vibra-Switch”. Also a range of pressure switches and PT-100 temperature sensors are produced. All instruments are developed and produced in our factory in Dwingeloo, The Netherlands. Klay Instruments has a world wide sales and service network in more than 45 countries.

Specialist in Flush Diaphragm Transmitters

Klay Instruments is specialized in manufacturing Pressure and Level transmitters with a strong Flush mounted diaphragm. All Klay transmitters with a flush diaphragm are equipped with the unique Klay Flush Diaphragm Technology. All transmitters are fully temperature compensated. We offer the following features with our F.D.T. system:

- ✓ **Advanced laser welding** techniques of diaphragm ①
- ✓ Strong diaphragm material. Standard polished (Ra < 0.15µm) ②
- ✓ Backup wave structure behind diaphragm (protection against overpressure) ③
- ✓ Pressure and temperature **sensor integrated right behind diaphragm** ④
- ✓ **Minimum oil filling** between sensor and diaphragm ⑤
- ✓ 100% Helium leak tested and Full vacuum resistant.
- ✓ **Active Temperature compensation**
- ✓ Diaphragm materials: SS 316L (standard), options: Hastelloy C, Tantalum or Gold plated.

(Detailed brochure from Klay Flush Diaphragm Technology available)

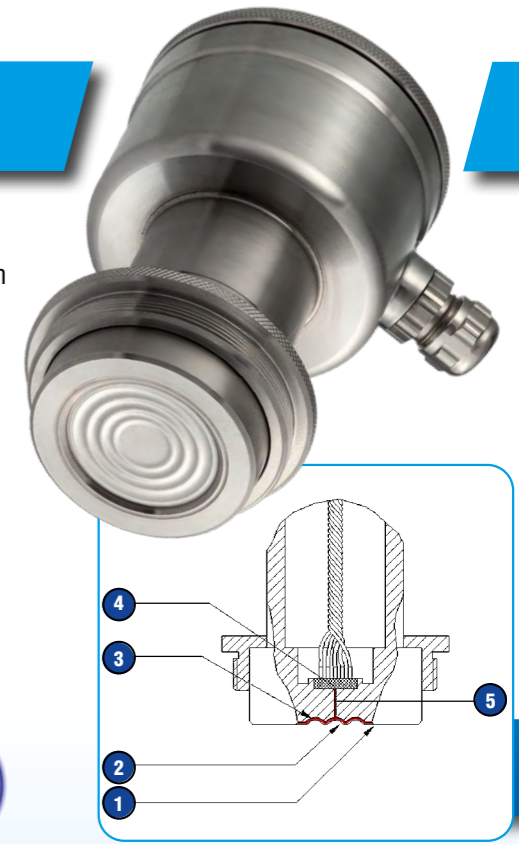

Klay advantages against oil filled capillary systems & remote seals

With our proven Flush Diaphragm Technology we have some big advantages against transmitters with oil filled capillaries and remote seals. Instead of using oil filled capillaries for remote electronics we use our strong Hytel cable (with venting tube inside) between the process connection and our Stainless steel electronics housing. This gives even more advantages than the above mentioned points.

Our major advantages are:

- ① **Strong and small diaphragm**
 - Laser welded
 - Standard polished
- ② **Minimum oil filling** by using our Flush Diaphragm Technology
- ③ **Backup Wave structure** behind diaphragm, equal to our diaphragm structure
- ④ **Pressure sensor near process**
 - Built-in Temperature sensor
 - Active temperature compensation
 - No mounting position effect
- ⑤ **Strong “vented” cable**
- ⑥ **Stainless steel Electronics housing**

Dis advantages capillary systems:

- Ⓐ **Large amount of oil filling;**
 - Sensitive for temperature fluctuations;
 - No temperature compensation; Expensive solution.
- Ⓑ **Large diaphragm,** more sensitive for damaging
- Ⓒ **Mounted on standard transmitter;**
 - No active temperature compensation;
 - Large mounting position effects
- Ⓓ **Pressure sensor too far from process**

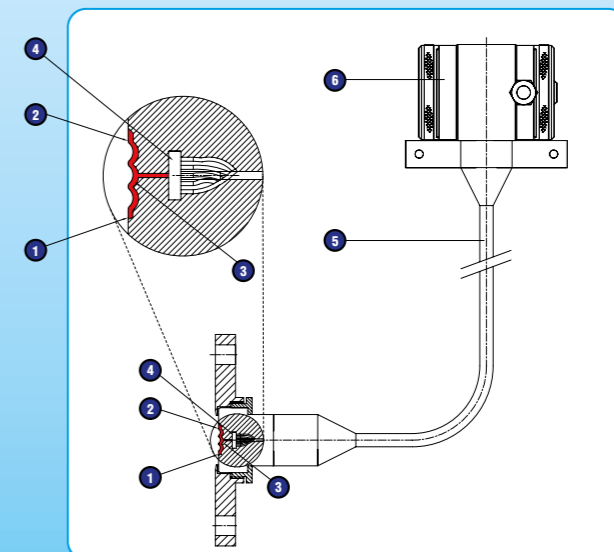

**All Klay transmitters from series 2000(SAN), 4000(SAN) and 8000(SAN) are available in a remote / separated version.*

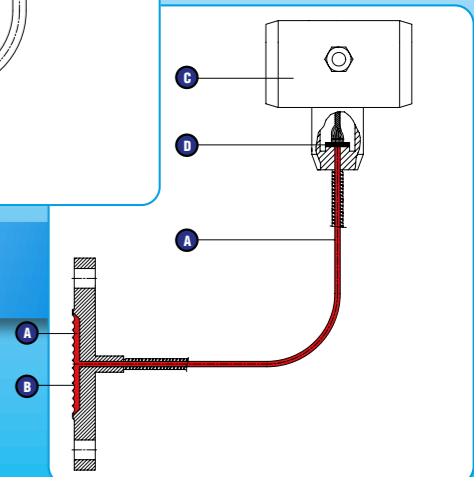

Analogue

Pressure and Level transmitters.
Zero and span adjustable by two potentiometers
Accuracy: 0.2%

Intelligent

Pressure and Level transmitters.
Easy adjustable without testpressure by 3 pushbuttons and a display.
Accuracy: 0.1%

High-end

Pressure and level transmitters
With Unique "One button" calibration and a graphic display.
Accuracy: 0.075%

Differential

Transmitter overview	Analogue			Intelligent			High-end		
Type	CER-8000	8000	8000-SAN	CER-2000	2000	2000-SAN	4000	4000-SAN	DP-4000
Process connections	Threaded G½" or ½" NPTm	G1" threaded Pulp & paper connections Flush mounted diaphragms	Hygienic connections, Flanges, threads, etc. More than 40! Flush mounted diaphragms	G½" or ½" NPTm	G1" threaded Pulp & paper connections Flush mounted diaphragms	Hygienic connections, Flanges, threads, etc. More than 40! Flush mounted diaphragms	G1" threaded Pulp & paper connections Flush mounted diaphragms	Flanges, threads, etc. Hygienic connections, More than 40! Flush mounted diaphragms	1/4 - 18 NPTf Option: Diaphragm Seals
Accuracy	0.2% of calibrated span			0.1% of calibrated span			0.075% of calibrated span		
Turn down		4:1			10:1		20:1		100:1
Span min...max	1 350 bar	0.1 100 bar	40 mbar 100 bar	1 350 bar	0.1 100 bar (option: till 1000 bar)	40 mbar 100 bar	0.1 100 bar (option: till 1000 bar)	30 mbar 100 bar	10 mbar 20 bar
Output	4-20 mA			4-20 mA Option: HART Protocol			4-20 mA Option: HART Protocol or Profibus PA		
Diaphragm material	Ceramic sensor	SS 316L flush diaphragm. Options: Hastelloy C, Tantalum or Gold plated		Ceramic sensor	SS 316L flush diaphragm. Options: Hastelloy C, Tantalum or Gold plated		SS 316L flush diaphragm. Options: Hastelloy C, Tantalum or Gold plated		SS 316L diaphragm. Opt.:Hastelloy C, Tantalum
Process temperature	-20°..... +80°C		-20°..... +100°C (145°C /45min) (option: HT max. 280°C)	-20°..... +80°C		-20°.....+100°C (145°C /45min) (option: HT max. 280°C)	-20°..... +80°C	-20°..... +100°C (145°C /45min) (option: HT max. 280°C)	-20°..... +100°C
Electronics housing	316 Stainless steel			304 Stainless steel (Option: SS 316)			304 Stainless steel (Option: SS 316)		
Calibration	By zero and span potentiometers			By 3 pushbuttons and display (without testpressure)			By 1 pushbutton and graphic display (without testpressure)		
Certificates / Approvals	ATEX Ex ia, IECEx ABS, Lloyds, DNV, BV, CCS (Marine) Gost, SIL2		ATEX Ex ia, IECEx 3A and EHEDG (Food) Lloyds, DNV, BV, CCS (Marine), Gost, SIL2	ATEX Ex ia, IECEx ABS, Lloyds, DNV, CCS (Marine) Gost, SIL2		ATEX Ex ia, IECEx 3A and EHEDG (Food) Lloyds, DNV, BV, CCS, ABS (Marine), Gost, SIL2	ATEX Ex ia and IECEx SIL 2 (pending)		
Applications	Pressure on gas, steam, vapour and clean fluids	Pressure on fluids, pulp & paper, starch, oil, etc	Pressure- and Level on fluids, pastes and sludges in all industries	Pressure on gas, steam, vapour and clean fluids	Pressure on fluids, pulp & paper, starch, oil, etc	Pressure- and Level on fluids, pastes and sludges in all industries	Pressure on fluids, pulp & paper, starch, oil, etc	Pressure- and Level on fluids, pastes and sludges in all industries	Differential Pressure on fluids, gases and steam
Features	<ul style="list-style-type: none"> Housing All Stainless steel (Compact and Rugged) All common hygienic connections, flanges and threaded connections Active Temperature compensation Klay Flush Diaphragm Technology (8000 and 8000-SAN) 			<ul style="list-style-type: none"> Easy calibration by 3 pushbuttons and display Housing All Stainless steel (Compact and Rugged) All common hygienic connections, flanges and threaded connections Active Temperature compensation Klay Flush Diaphragm Technology (2000 and 2000-SAN) 			<ul style="list-style-type: none"> Easy calibration by 1 pushbutton and graphic display Housing All Stainless steel (Compact and Rugged) All industrial process connections Active Temperature compensation Klay Flush Diaphragm Technology (4000 and 4000-SAN) 		



Series 8000

Analogue Pressure Transmitters

Features series 8000

0.2%



CER-8000
"Peramic"



- ✓ ACCURACY: 0.2% FROM ADJUSTED SPAN
- ✓ TURN DOWN 4:1
- ✓ ZERO AND SPAN INTERNALLY ADJUSTABLE
- ✓ STAINLESS STEEL HOUSING
- ✓ ACTIVE TEMPERATURE COMPENSATION
- ✓ RANGES FROM 80 MBAR TO 350 BAR
- ✓ ALL INDUSTRIAL PROCESS CONNECTIONS
- ✓ STRONG FLUSH DIAPHRAGMS



CER-8000/"Peramic"

Pressure transmitters with a ceramic sensor for Pressure measurement on clean fluids, gases and vapours. Process connections: G½" or ½" NPT. Available ranges: from 0-1 bar to 0-350 bar

8000

Pressure transmitters with a **small and strong flush mounted diaphragm** for pressure applications on sticky fluids where a flush diaphragm is necessary like pulp & paper, starch, etc. Process connections: G½", G1" and special pulp & paper connections (PMC, etc). Available ranges: 0 - 0.1 bar to 0 - 100 bar

8000-SAN

Pressure- and Level transmitters with **strong flush mounted diaphragms** for all kind of fluids, pastes and sludges. They are specially designed to use in the Food, Pharma and (Petro)chemical industry. There is a wide selection of process connections available (more than 50!) among them there are many **hygienic process connections**, most of them are **EHEDG and 3-A certified**. The 8000-SAN transmitters are both CIP and SIP cleanable.

Separate housing / remote electronics

With a "separate housing" version you are able to mount the electronics housing at a distance from the process connection. The process connection and electronics housing are joined by a special "vented" cable (IP68). **Applications** can be on locations with difficult access, wet area, high process vibrations, high process temperatures, etc. All 8000 and 8000-SAN types are available with the separate housing. Cable length must be specified at the order.

Type: 8000-SAN-Cable(.m)-range-... (See detailed product brochure).

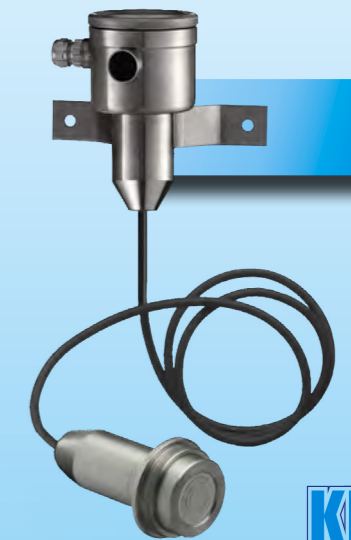
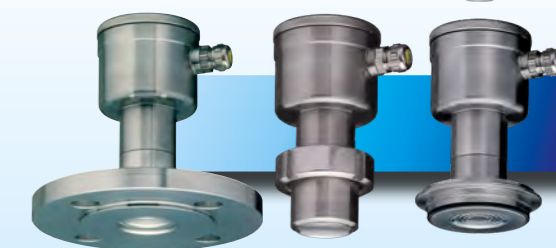
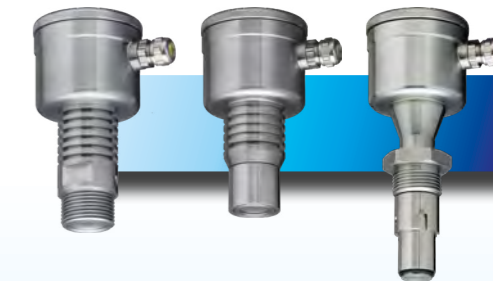

8000



8000-SAN



Series 2000

"Intelligent" Pressure and Level Transmitters

Features series 2000

0.1%



CER-2000
Peramic "S"



- ✓ ACCURACY: 0.1% FROM ADJUSTED SPAN
- ✓ TURN DOWN 10:1
- ✓ EASY CALIBRATION WITHOUT TESTPRESSURE BY 3 PUSHBUTTONS
- ✓ STAINLESS STEEL HOUSING
- ✓ ACTIVE TEMPERATURE COMPENSATION
- ✓ RANGES FROM 40 MBAR TO 350 BAR
- ✓ ALL INDUSTRIAL PROCESS CONNECTIONS AVAILABLE
- ✓ STRONG FLUSH MOUNTED DIAPHRAGMS
- ✓ EASY TANK LINEARISATION



CER-2000 / Peramic "S"

Pressure transmitters with a ceramic sensor for pressure measurement on clean fluids, gases and vapours. Process connections: G ½" or ½" NPT. Available ranges: from 0-1 bar up to 0-350 bar

2000

"Intelligent" Pressure transmitters with a **small and strong flush mounted diaphragm** for pressure applications on sticky fluids where a flush diaphragm is necessary like pulp & paper, starch, etc. Process connections: G½", G1" and special pulp & paper connections (ie, PMC, etc). Available ranges: 0 - 0.1 bar up to 0 - 100 bar.

2000-SAN

"Intelligent" Pressure and Level transmitters with **strong flush mounted diaphragms** for all kind of fluids, pastes and sludges. They are specially designed to use in the Food, Dairy and Pharma industries, pulp & paper and (Petro)chemical industry. There is a wide selection of process connections available (more than 50!) among them there are many **hygienic process connections**, most of them are **EHEDG and 3-A certified**. The 2000-SAN transmitters are CIP and SIP cleanable. Available ranges: 0 - 40 mbar up to 0 - 100 bar

Separate housing / remote electronics

With a "separate housing" you are able to mount the electronics housing at a distance from the process connection. The process connection and electronics housing are joined by a special "vented" cable (IP68). **Applications** can be on locations with difficult access, wet area, high process vibrations, high process temperatures, etc. All 2000 and 2000-SAN types are available with the separate housing. Cable length must be specified at the order. Type: 2000-SAN-Cable(..m)-range-...



2000



2000-SAN



Series 4000

"Intelligent" Pressure and Level Transmitters

Features series 4000

0.075%



4000



- ✓ ACCURACY: 0.075% FROM ADJUSTED SPAN
- ✓ TURN DOWN 20:1
- ✓ UNIQUE "ONE TOUCH PROGRAMMING BUTTON"
- ✓ STAINLESS STEEL HOUSING
- ✓ GRAPHIC DISPLAY INCL. BARGRAPH AND BACKLIGHT
- ✓ ACTIVE TEMPERATURE COMPENSATION
- ✓ RANGES FROM 30 MBAR TO 100 BAR
- ✓ ALL INDUSTRIAL PROCESS CONNECTIONS AVAILABLE
- ✓ STRONG FLUSH MOUNTED DIAPHRAGMS
- ✓ EASY TANK LINEARISATION



HART
COMMUNICATION PROTOCOL

PROFIBUS



4000-SAN



4000

"Intelligent" High-end Pressure transmitters with a **small and strong flush mounted diaphragm** for pressure applications on sticky fluids where a flush diaphragm is necessary like pulp&paper, starch, oil, etc. Process connections: G1/2", G1", special pulp & paper connections (PMC, etc). Available ranges: 0 – 0.1 bar up to 0 – 100 bar



4000-SAN

"Intelligent" High-end Pressure- and Level transmitters with strong flush mounted diaphragms for all kind of fluids, pastes and sludges. They are specially designed to use in the Food, Dairy and Pharma industries, pulp & paper, (Petro)chemical and oil & gas industry. There is a wide selection of process connections available (more than 50!) among them there are many **hygienic process connections**, most of them are **EHEDG and 3-A certified**. The 4000-SAN transmitters are CIP and SIP cleanable. Available ranges: 0 – 30 mbar up to 0 – 100 bar



Easy Tank linearisation

Various tankshapes are already pre-programmed in the series 4000(SAN) which ensures a **very easy tank linearisation**.

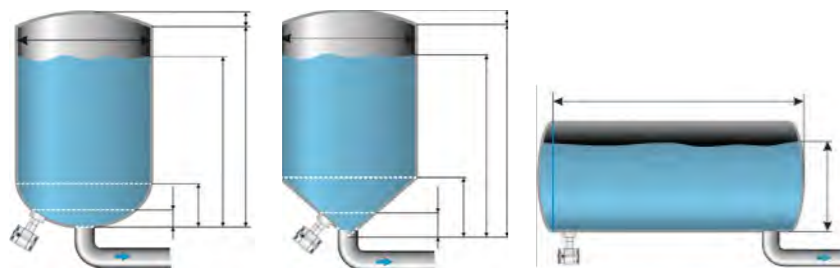

The standard tank shapes are:

- Horizontal tank with flat end
- Horizontal tank with parabolic end
- Vertical tank with a spherical bottom
- Vertical tank with a conical bottom

In addition, a free linearization curve of up to 50 points is adjustable.

Separate housing / remote electronics

With a "separate housing" version you are able to mount the electronics housing at a distance from the process connection. The process connection and electronics housing are joined by a special "vented" cable (IP68). **Applications** can be on locations with difficult access, wet area, high process vibrations, high process temperatures, etc. All 4000 and 4000-SAN types are available with the separate housing. Cable length must be specified at the order. Type: 4000-SAN-Cable(..m)-range-...



Specifications:

Accuracy	: 0.075% (option: 0.065%)
Ranges	: 0-10 mbar to 0 – 20 bar
Turn down	: up to 100:1
Adjustment	: by One pushbutton and graphic display, without testpressure
Output	: 4-20 mA + HART® Protocol (version 5.0 or 7.0)
Supply	: 12 – 36 Vdc
Electronics housing	: AISI 304 (Option: AISI 316)
Protection	: IP66/67 (option IP68)
Process temperature	: -20°C to 80°C (option: 100°C)
Ambiant temperature	: -20°C to 70°C
Material wetted parts	: AISI 316L (option: Hastelloy C)
Material diaphragm	: AISI 316L (option: Hastelloy C, Tantalum or Gold plated)
Material sensor gasket	: Viton/FKM (standard), PTFE or NBR
Process connection	: 1/4 - 18 NPT female
Option	: 1/2" NPTf (by oval flanges)

Graphic display with bargraph and backlight

Multilingual: English, Dutch, German, French, Spanish, Russian and Polish



360° Rotatable display



Unique 'One Touch Programming Button'

The series DP-4000 is carried out with a **unique control button**. This 'single button' can be used for all programming /calibration functions.

Options:



3 or 5 way Manifold

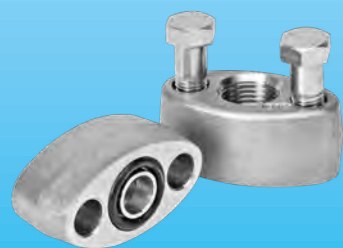

Oval flanges



- ✓ **ACCURACY: 0.075%**
- ✓ **TURN DOWN UP TO 100:1**
- ✓ **UNIQUE, ONE TOUCH PROGRAMMING BUTTON**
- ✓ **STAINLESS STEEL HOUSING**
- ✓ **GRAPHIC DISPLAY INCL. BARGRAPH AND BACKLIGHT**
- ✓ **EASY CALIBRATION WITHOUT TESTPRESSURE**
- ✓ **RANGES FROM 5 MBAR TO 20 BAR**
- ✓ **EASY CURRENT SIMULATION**
- ✓ **BUILT-IN SQUARE ROOT FUNCTION (FLOW)**



The DP-4000 is an Intelligent differential pressure transmitter with a compact and rugged Stainless steel electronics housing. The calibration / programming can be done very easily without testpressure by using the programming button together with the Graphic display with backlight. For flow measurement a square root function is built-in with adjustable cut off point. The output is 4-20 mA including HART® protocol. Profibus PA is available as an option. For use in hazardous areas ATEX Ex ia and IECEx approvals are available.

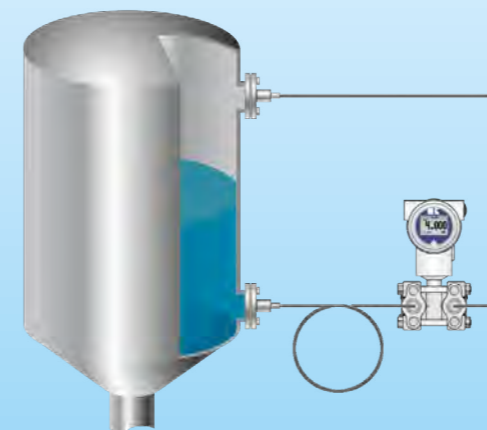

DP-4000 with diaphragm seals:

For dP applications like **level measurement in closed pressurized tanks** a DP-4000 with diaphragm seals is available. Various process connections are available like Flange, Milkcoupling or Tri-Clamp. Capillary tube attachments are available in various lengths with different oil fillings.

- Diaphragm seal process connections:
- ▶ Flange (DN 50 to DN 100 (2" to 4") (Option with extension)
 - ▶ Milkcoupling DN 50 to DN 80
 - ▶ Tri clamp 2" to 4"

Wetted parts are standard SS 316L

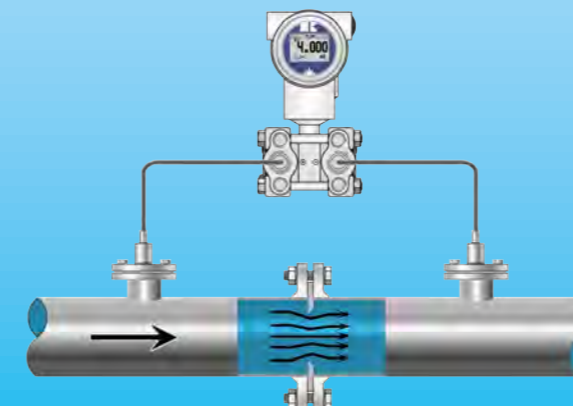

Option: Hastelloy C, Tantalum, Titanium, Gold plated, etc.



Flow measurement using DP-4000 with primary elements

Differential pressure / flow transmitters are used in many industrial applications. Most used primary flow elements are **orifice plates** and **pitot tubes**. The differential pressure generated by the primary element is normally transformed into an electrical (4-20 mA) signal proportional to the flow rate by the differential pressure transmitter. The Klay DP-4000 has as standard a **built-in flow square root function with adjustable cut off point**.

Selection Table

	1 Hydrobar -Cable-FR	2 Hydrobar-Cable-Range	3 Hydrobar-EXTD-Range	4 Hydrobar-'I'	5 2000-Hydrobar-Cable	6 2000-Hydrobar-EXTD	7 HydroCER-Cable-FR	8 HydroCER-'I'	9 AquaCER-Cable
StSt 316L Diaphragm									
Ceramic sensor									
Fixed Range									
Adjustable range									
Accuracy 0.2%									
Accuracy 0.1%									
Output 4-20 mA									
HART® Protocol  (option)									
Local display (option)									
ATEX  and  Ex ia (option)									
Marine Type Approvals									
Sensor Diameter (mm)	38 or 50	38 or 50	38 or 50	38 or 50	38 or 50	38 or 50	38 or 50	38 or 50	22
Klay Drawing No.	8000-13	8000-14	8000-35	2000-13	2000-14	2000-35	8000-113	2000-113	

Cable material:

- PE (Polyethylene) diam. 8 mm = standard
- Hytrel (code: G10) diam. 10 mm (option / extra price)
- PUR (Polyurethane) (option) diam. 8 mm

Mounting possibilities (topmounting):

- Cable clamp (Option: Art. No.: 20636)
- Wall mounting bracket (standard with all adjustable types)
- Flange (topmounted) according to Klay drawing no.: 8000-15 / 2000-15
- Threaded connection (1½" or 2" BSP)



Cable clamp
Art. no. 20636



JunctionBox FMD(IP67)
Art. no. 20171

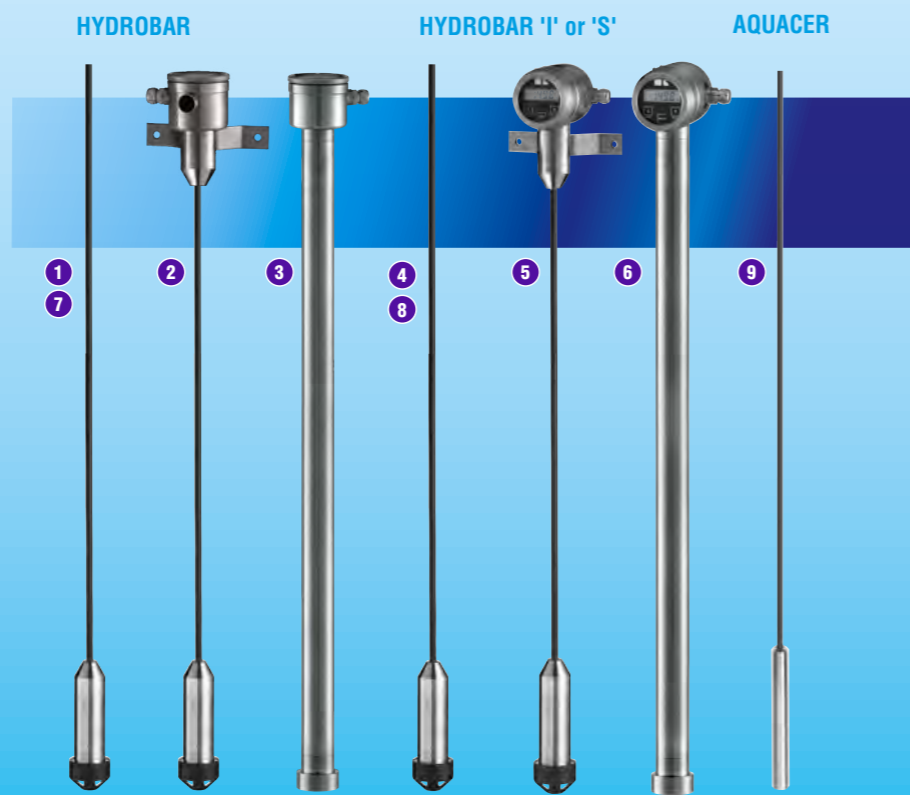

See explanation on page 15

Klay Instruments offers a wide range of submersible Level transmitters with a cable or SS tube extension, to be used as topmounted level transmitters in water and waste water, deep wells, underground tanks, concrete bunkers, etc. All transmitters are **fully temperature compensated** and most of them are internally adjustable on zero and span. The output is 4-20 mA / 2-wire. The SS 316L diaphragms from series **Hydrobar** are very strong and laser welded, this results in a Perfect Long term stability. The series **HydroCER** are made with a strong **capacitive ceramic sensor**. Options include HART® Protocol and ATEX Ex ia Intrinsic safety.

Types with Stainless Steel diaphragm:



- Hydrobar-Cable-FR** (Fixed range, not adjustable)
Accuracy: 0.2% from adjusted span
- Hydrobar-Cable-Range**
Adjustable on zero and span by potentiometers
Accuracy: 0.2% from adjusted span
- Hydrobar-EXTD-Range** (SS tube extension)
Adjustable on zero and span by potentiometers
Accuracy: 0.2% from adjusted span

"Intelligent" types:

- Hydrobar-'I'-Cable-range**
Intelligent level transmitter
Adjustable by HART® Protocol or PC. Accuracy: 0.1% from adjusted span
- 2000-Hydrobar-Cable-range**
- 2000-Hydrobar-EXTD-range**
Easy adjustable by 3 pushbuttons and display without testpressure.
Accuracy: 0.1% from adjusted span. For all Features see series 2000 on page 9.
The display can be used during programming and can also indicate the process temperature or the measured level. A tanklinearisation can be done and a 4-20 mA current simulation can be performed. Mounting can be done by cable clamp, wall mounting bracket, Flange (DIN or ANSI) or a threaded connection G1½" or 2" BSP or NPT).

Types with Capacitive Ceramic sensor:

- HydroCER-Cable-FR** (Fixed range, not adjustable)
Accuracy: 0.2% from adjusted span
- HydroCER-'I'-Cable-range**
Intelligent level transmitter
Adjustable by HART® Protocol or PC.
Accuracy: 0.1% from adjusted span
- AquaCER-Cable-range**
Sensor diameter 22 mm

- ✓ ACCURACY 0.2% OR 0.1% FROM ADJUSTED SPAN
- ✓ ACTIVE TEMPERATURE COMPENSATION
- ✓ PERFECT LONG TERM STABILITY
- ✓ STRONG FLUSH DIAPHRAGMS
- ✓ ZERO AND SPAN ADJUSTABLE
- ✓ ATEX  II1G Ex ia or IECEx 

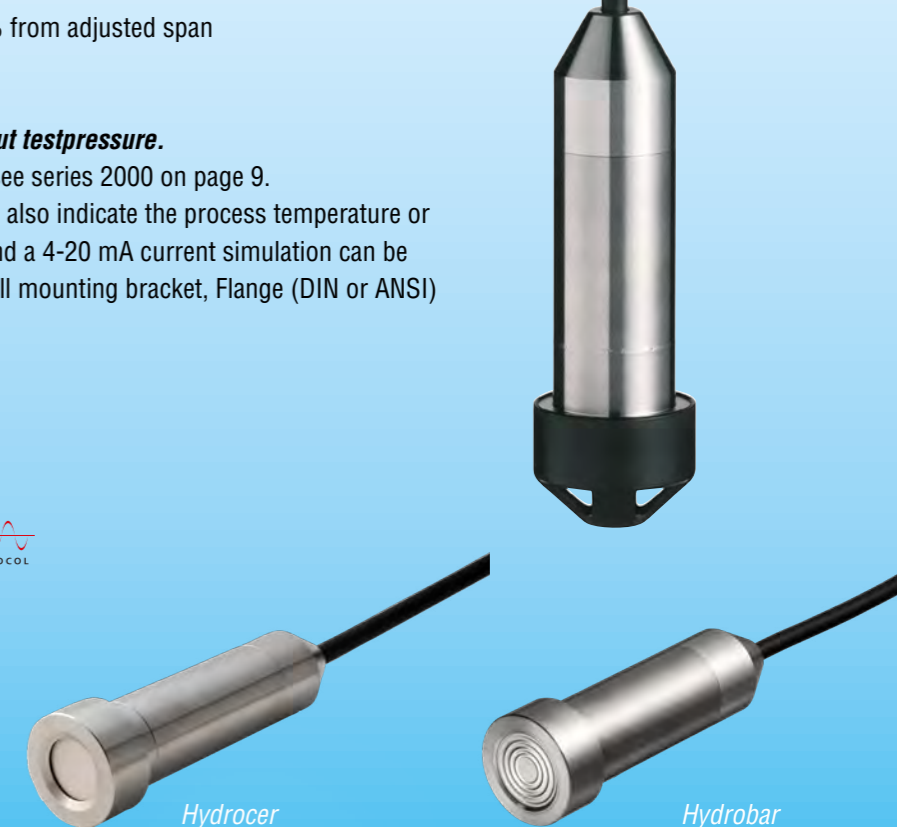

Specialist in “Specials”

In the past 40 years we have made Pressure and Level transmitters in many creative constructions. Most of them have become a standard in our factory now, like the versions mentioned on this page. If you have a special process connection and you need to replace an existing transmitter, do not forget to ask the **Specialist in “Specials”!**

Valve Pressure transmitters “exchangeable during process”

The series 8000-Valve and 2000-Valve are a combination of a level transmitter and a special ball-valve. The design permits flush installation of the diaphragm and **a transmitter that can be removed without shutting down the process.** Process connections are DIN or ANSI Flanges, a G1½” threaded connection or special weld-on nipples in various diameters. Ranges are available from 100 mbar to 16 bar. For lower ranges we use a 1½” valve size and for pressure ranges we can use a smaller 1” valve size.

High Temperature (HT) Versions:

For High temperature applications we manufacture the series 8000-SAN and 2000-SAN with special **cooling fins** or with separated electronics. The compact versions with cooling fins can measure up to 180°C and with cooling fins and separated electronics we can measure up to 300°C. The lowest span range for these high temperature versions is 0.5 bar.

Homogenizer transmitters:

For high pressure applications on Homogenizers in the Food- and Dairy we manufacture an “Intelligent” high pressure transmitter with the typical homogenizer process connection. These transmitters are executed with an **unbreakable SS flush diaphragm**! Biggest problem by measuring pressure with pressure gauges or pressure transmitters on homogenizers is the stability and the damage of the flush diaphragm. With our series 2000 Homogenizer transmitters a broken diaphragm is history! The 2000-Homogenizer transmitters are available in compact version or in a version with separate electronics. Many different homogenizer block process connections are available.

Extended diaphragms:

The series 2000- and 8000-SAN-EXTD are Flange mounted Level transmitters with an extended diaphragm. The extension length and diameter must be specified, always refer to our drawing no. 8000-61. The transmitters do have a strong flush mounted diaphragm and are fully temperature compensated. Technical specifications are equal to the standard series 2000-SAN and 8000-SAN.



Features series 3000

- ✓ ACCURACY: 0.2% FROM ADJUSTED SPAN (OPTION: 0,1%)
- ✓ TURN DOWN 10:1
- ✓ EASY CALIBRATION WITHOUT TESTPRESSURE BY 3 PUSHBUTTONS
- ✓ STAINLESS STEEL HOUSING
- ✓ ACTIVE TEMPERATURE COMPENSATION
- ✓ RANGES FROM 40 MBAR TO 50 BAR
- ✓ ALL INDUSTRIAL PROCESS CONNECTIONS AVAILABLE
- ✓ FLUSH MOUNTED CAPACITIVE CERAMIC SENSOR
- ✓ EASY TANK LINEARISATION

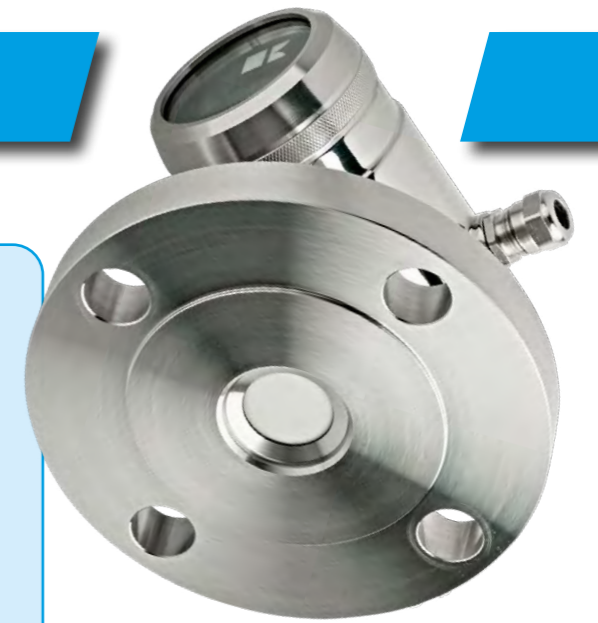

3000

“Intelligent” Pressure transmitters with a **small and strong ceramic sensor** for pressure applications on sticky fluids where a flush diaphragm is necessary like pulp & paper, starch, etc. Process connections: G1” and special pulp & paper connections (i.e. PMC, etc). Available ranges: 0 - 0.1 bar up to 0 - 50 bar.

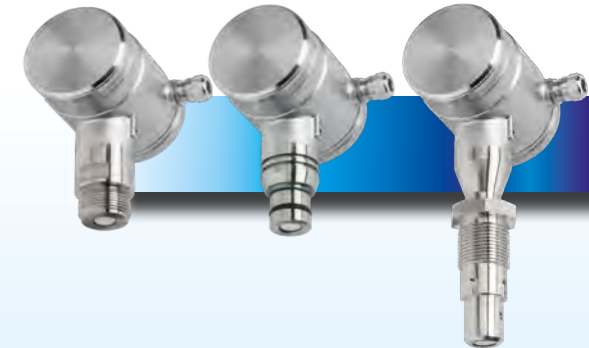

3000-SAN

“Intelligent” Pressure and Level transmitters with a strong ceramic sensor for all kind of fluids, pastes and sludges. They are designed to be used in the Process industry, pulp & paper, food, chemical and mining industry. There is a wide selection of process connections available (more than 20). Available ranges: 0 - 0.1 bar up to 0 - 50 bar.



IP 68 Transmitters:

Our Klay Pressure and Level transmitters are also available in an IP68 version. This can be either the series 3000 in a remote version or our type HydroCer with all electronics compact mounted in the sensor part. All process connections are available in this execution, see picture right as an example from our IP68 Flanged level transmitter.

Type: HydroCer-I-Cable(.m)-range-(Process connection code).
Always mention cable length, range and process connection.

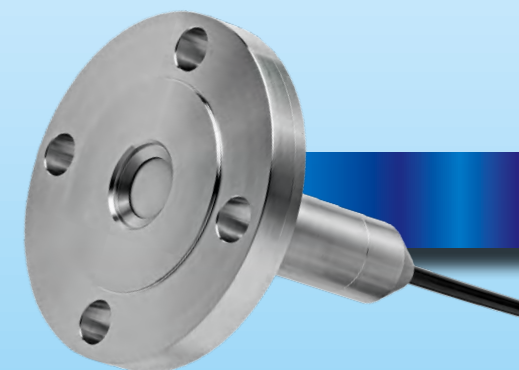

Temperature Transmitters

- ✓ All Stainless steel Electronics housing
- ✓ High accuracy (1/3 DIN) and Fast response time
- ✓ Outputs: RTD 3-wire or 4-20 mA
- ✓ HART Protocol and PROFIBUS PA (options)
- ✓ All industrial process connections
- ✓ ATEX and IECEx II1G Ex ia certified
- ✓ Intelligent TT-4000 with Graphic Display
- ✓ Thermowells available in many executions

Description:

Klay Instruments offers a **complete range of RTD (PT-100) temperature sensors / transmitters**. All industrial and hygienic process connections are available with many different insertion lengths and diameters.

Certificates include ATEX / IECEx intrinsic safety and EHEDG / 3A Food certificates.

The connection head is always made from Stainless Steel, fast response time and vibration resistance are standard as well !

Besides the single 3-wire system a 'double' system (2xPT100) is also available. When using our 'head mounted' transmitter the output can be 4-20 mA / 2-wire (Option: HART Protocol).

TT-4000

In addition to the standard (basic) PT-100 sensors we also offer a line of **'Intelligent' temperature transmitters, series TT-4000**. These transmitters are easy adjustable by one single programming button and a **Graphic display with backlight as standard**.

The output is 4-20 mA, options include HART Protocol or Profibus PA.

For use in hazardous areas ATEX Ex ia and IECEx approvals are available.

Thermowells:

A wide range of thermowells are available, like:

- Weld-in type
- Screw type (all BSP / NPT threads)
- Flanged (All DIN and ANSI sizes)

Bar stock thermowells are also available in various materials.



TT-4000

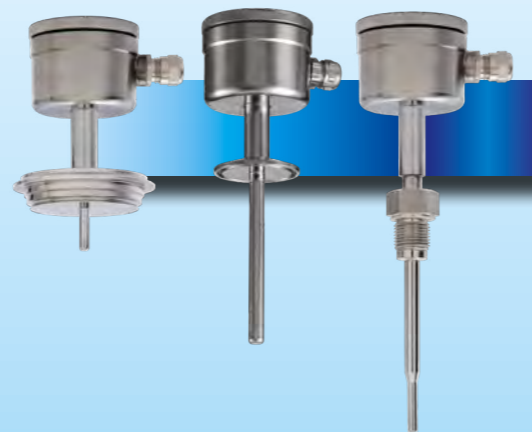

Level Switches for fluids

Klay Instruments offers a wide range of "All Stainless" levelswitches mainly for use in the Food & dairy and Pharmaceutical industries and the water & waste water industry.

The offered measuring principles are:

- **Tuning Fork** series **Vibra-Switch**, type **VSC** and **VSS**
- **Conductivity** based levelswitch, type **FLX**
- **Electromagnetic wave**, type **KMW**

Tuning Fork levelswitch: "Vibra-Switch"

The "Vibra-Switch" levelswitches are available in 2 versions. The compact version with connector or cable connection, type **VSC** and the rugged and compact version with a complete **Stainless Steel electronics housing** type **VSS**.

Both versions are based on the tuning fork principle. They are available in various sanitary process connections such as Tri-clamp, milkcoupling or a threaded version (G1"). All flange sizes (DIN / ANSI) are available too. Insertion lengths vary from 47 mm to extended versions of 2.5 meter. Both types are CIP and SIP cleanable.

Conductivity based: FLX

The "FLX" levelswitch is based on the principle of conductivity and is a very rugged designed "All stainless steel" levels witch. All standard process connections, like G1" thread, milkcoupling, Tri-clamp and Flanges are available. Insertion lengths are starting from 30 mm to 2 meter.

Electromagnetic waves: KMW

The hygienic level switch KMW is microprocessor based and can be installed in any position in tanks or piping systems. The measuring principle is an electromagnetic wave (100...180MHz). A high frequency signal sweep is radiated from the sensor tip into the tank or pipe.

The medium acts as a virtual capacitor, which together with a coil in the sensor, will form a circuit creating the switching point. Therefore the KMW is suitable for almost all liquids and paste-like medias.

To adjust the sensitivity there are two possibilities, by internal dipswitch or via PC with software. For viscous and adhesive medias the KMW is available with an extended PEEK sensor (No. 1). **Applications** are high and low level detection in tanks and dry run protection of pumps in the Food & Beverage and Pharmaceutical industry. The KMW-LC (No. 3) is the most economic version with easy adjustability by Klay software.

All common hygienic process connections are available.

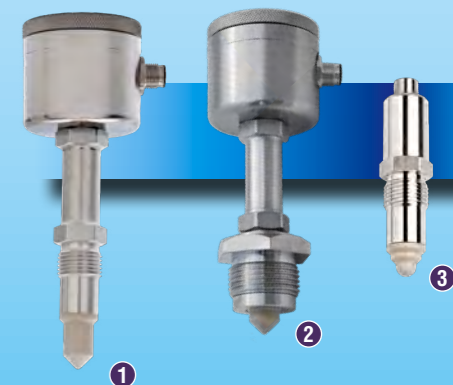
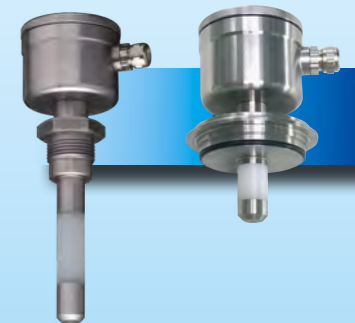
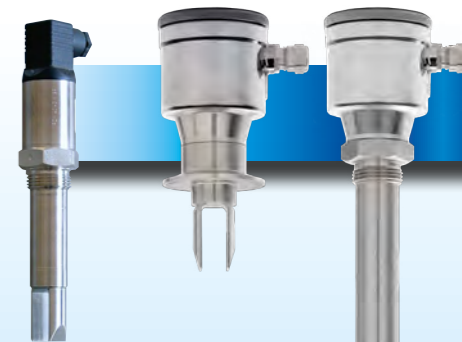

KLAY-INSTRUMENTS WORLD WIDE



Klay instruments has a world wide sales and distribution network in more than 45 countries. Please ask for your local representative, there will always be one in your area.

Brochures

In this brochure we show an overview of our complete production program. A detailed technical brochure is available from each product line. Visit our website www.klay.nl to download these brochures or call one of our inside sales engineers at (+31)521 591550. On request we can send you our general catalog with all detailed brochures.



Approvals

A lot of approvals & certificates are available for many transmitters and industries. If you require an approval/certificate which is not mentioned please contact us.



Scan the QR-code or download all the available brochures on... www.klay.nl



Manufactured by:

KLAY-INSTRUMENTS B.V.

Nijverheidsweg 5
P.O. Box 13
T: +31-521-591550

7991 CZ DWINGELOO
7990 AA DWINGELOO
The Netherlands

E: info@klay.nl www.klay-instruments.com

Our representative in your area is: