

INSTRUCTION MANUAL TT-2000

Pt-100 TEMPERATURE TRANSMITTER



Manufactured by

 **KLAY-INSTRUMENTS**

www.klay-instruments.com

Nijverheidsweg 5
P.O. Box 13
Tel. +31-521-591550
Fax +31-521-592046

7991 CZ Dwingeloo
7990 AA Dwingeloo
The Netherlands
Email: info@klay.nl

CONTENTS

SECTION		PAGE
1	Introduction	3
1.1	Description Series TT-2000	3
2	Dimensional drawings	3
2.1	Dimensional drawings TT-2000	3
3	Installing transmitter	4
3.1	Installing weld-on nipple	4
3.2	Mounting position	4
3.3	Calibration	4
3.4	Wiring	5
4	Remaining	6
4.1	Digital local indicator	6
4.2	CE / EMC Rules	6
4.3	External load	6
4.4	Intrinsically Safe (Ex-version)	7
4.5	Traceability year of manufacturing	8
4.6	Software revisions	8
5	Functions of push buttons	8
6	Programming points (P101-P110)	9
7	Reading on the display	9
8	Explanation programming points P101 to P112	10
	P101 Zero adjustment (4 mA)	10
	P102 Span adjustment (20 mA) without test temperature	10
	P103 Corrections temperature read out	10
	P104 Adjustment temperature units	11
	P105 Reverse output (20-4 mA)	11
	P106 Adjustment damping (0 till 25 sec)	11
	P107 Indication of ambient temperature	11/12
	P108 Read out on display	12
	P109 Simulation of current	12
	P110 Write protection	12
	P111 Service menu	12
	P112 Service menu	12
9	Precautions and warnings	13
	Attachment: EU-Declaration of conformity	14

1 INTRODUCTION

1.1 DESCRIPTION OF THE SERIES TT-2000

The TT-2000 Series is a complete Stainless Steel temperature transmitter, based on a Pt-100 element (1/3 DIN class B). The range of standard elements can be set between -50 and 200°C. Other ranges are available on request. The Pt-100 element is mounted in a stainless steel plug (sensor position 9). To obtain an accurate and fast measurement, the diameter of the insert part has to be chosen as small as possible. The resistance change of the Pt-100 element due to temperature change is converted into a proportional 4-20 mA signal (2-wire).

A great diversity in designs and process connections can be made including the milk couplings (DN25, 40 and 50), Tri-clamp (1, 1 1/2 "or 2") and hygienic weld-on-nipples as 3/4 "BSP nut (diam. 28 mm).

Associated immersion tubes (called Thermo Wells) fully welded and manufactured from execution (called "bar stock") are available in various designs and materials (on request).

2 DIMENSIONAL DRAWINGS

2.1 DIMENSIONAL DRAWING TT-2000

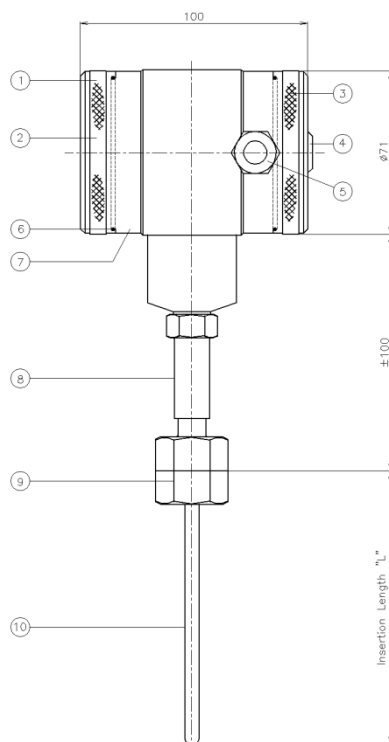

PARTS DESCRIPTION MATERIAL

- | | | |
|-----|-------------------------------------|--------|
| 1. | Cover | SS 304 |
| 2. | Pushbutton + Display | |
| 3. | Cover with venting | SS 304 |
| 4. | Venting | PBT |
| 5. | PG9 Cable Gland | PBT |
| 6. | O-ring (2 pcs) | EPDM |
| 7. | Electronics housing | SS 304 |
| 8. | Neck tube | SS 304 |
| 9. | Process connection | SS 316 |
| 10. | Insertion part | SS 316 |
| | Sensor tip | |
| | Specify Length (L) and diameter (D) | |

3 INSTALLING TRANSMITTER

3.1 INSTALLING WELD-ON NIPPLE

A skilled machinist or welder should perform installation of the weld-on nipple. Weld Argon, MIG or TIG with the smallest welding pin.

1. Cut a hole in the process vessel/pipe to accept the weld-on nipple.
2. Remove the weld-on nipple from the transmitter.
3. Position a welding mandrel into the weld-on nipple and screw it down.

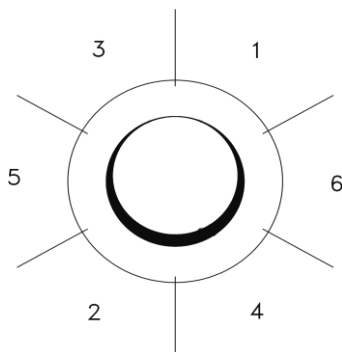

WARNING:

NEVER WELL THE ENTIRE CIRCUMFERENCE AT ONCE. Excessive heat input will deform the weld-on-nipple. Cool each and every well after each reading.

4. Position the weld-on nipple in the vessel hole and tack six places.
5. The weld sequence is shown in the figure above. Weld the weld-on nipple in place using 0,03 to 0,045 in. (0,762 to 1,143 mm) stainless rod as filler material in the beveled area. Adjust amperage for penetration. pliers (1/8").
6. Remove mandrel after the welding operation.

3.2 MOUNTING POSITION

When the transmitter is mounted horizontally, the cable gland **MUST** be pointed downwards.

3.3 CALIBRATION

All transmitters are fully calibrated at the factory, to the conditions stipulated in users order. When the buyer has not requested calibration, the transmitter will be calibrated 0-100°C.

3.4 WIRING

Under the cover (3) you will find the terminal board.

The push buttons "Zero", "Span" and "Prog" are under the other cover (1).

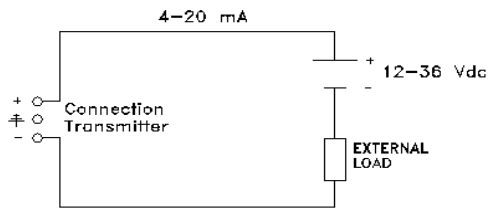

External equipment should preferably be connected to the negative side of the 2-wire system. The figure on the left shows the connection board of the transmitter. The connecting wires must be connected to terminal 3 (-) and 4 (+)

The screw terminal tightening torque range needs to be: minimum 1.0 Nm (8.85 in-lb); max. 1,2 Nm (10.62 in-lb).

Remove approx. 5 cm (2 in) of the cable mantle, strip approx. 1 cm (0.4 in) of insulation from the ends of the individual wires. When using stranded cable apply the correct end sleeves for the wires and make sure these are connected properly underneath the screw terminals.

The field wire conductor cross-section needs to be: minimum 0,2 mm² (24 AWG) and maximum 1,5 mm² (16 AWG).

External loads must be placed in the negative leg of the 2-wire loop.

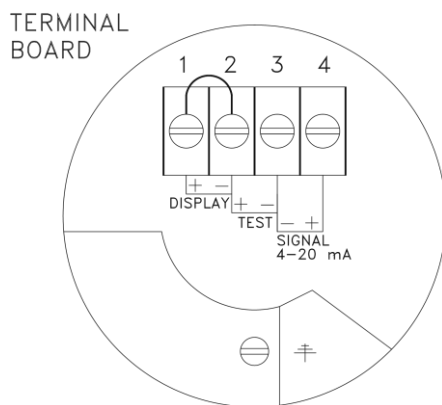

The figure left shows the wiring connection of the transmitter. The 2-wires must be connected to 3(-) and 4 (+) of the terminal board.

The signal wiring must be shielded and twisted pairs yield best results. **Do NOT** run signal wiring in open trays with power wiring, or near "heavy" electrical equipment (E.g.: Frequency controller or heavy pumps). Shielding must always be connected at the side of the power supply.

In case the mounting position is already connected to earth (e.g. via the tank or pipe line) **do NOT** connect the instrument to earth. **Please ensure that the instrument is not connected to earth twice to prevent the occurrence of an 'earth loop'**. In applications with synthetic mounting positions the case grounding terminal (internal or external) must be connected to earth.

Care must be taken to assure that the polarity of the power supply is correct, a reversal of wiring polarity will not damage the transmitter, but it will not function until the wiring is connected correctly.

4. REMAINING

4.1 DIGITAL LOCAL INDICATOR

All temperature transmitters from the series TT-2000 are standard equipped with a digital display. In the standard execution the covers are "closed". The three push buttons and the display are behind the cover (3).

As an option an "open" cover can be delivered to achieve the display can be used as a local display in the process (Option: "I" extra price). The full-scale point may be set to any value between 0000 and 9999 (4 digit)

4.2 CE / EMC Rules

All Klay transmitters are manufactured in accordance with the RFI / EMC directives and comply with the CE standard. All transmitters are fitted with RFI filters, which provide optimum, trouble-free operation. Our products are in conformity with EMC-Directive 2014/30/EU based on test results using harmonized standards.

4.3 EXTERNAL LOAD

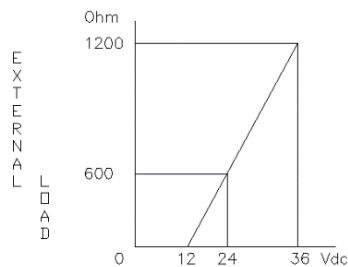

The minimum power supply is based on the total circuit resistance.

The maximum permissible load(Ri max.) in case of 24 Vdc is 600 Ω (Ohm).

By increasing the power supply, the external load can be increased to 1200 Ohm / 36 Vdc. (see figure left).

$$Ri \text{ max.} = \frac{\text{Power Supply} - 12 \text{ Vdc}}{20 \text{ mA}}$$

4.4 INTRINSICALLY SAFE (Ex version):

The Series TT-2000 is also available for intrinsically safe (Zone 0) for **ATEX** and **IECEX** (option, extra price).

ATEX – DEKRA 20ATEX0025 X

II 1G Ex ia IIC T4 Ga

II 2D Ex ib IIIC T100°C Db (option G100, extra price)

IECEX – DEK 14.0079X

Ex ia IIC T4 Ga

Ex ib IIIC T100°C Db (option G100, extra price)

Ex ec IIC T4 Gc (option G180, extra price)

ATE - DEKRA 20ATEX0026X

II 3G Ex ec IIC T4 Gc (option G180, extra price)

The transmitters with EPL Gc (option G180) shall only be used in an area of at least pollution degree 2 (Zone 2 for Gases), as defined in IEC 60664-1.

For use in a **non-sparking** area, the transmitter can be installed without the use of a (intrinsic safe) barrier. The transmitter can be connected with the following nominal value's :

$U_N = 12...26.5$ Vdc; $I_N = 4...20$ mA; $P_N = 0,28$ W

Use a certified power supply in an intrinsic safe area from: 12 - 26,5 Vdc.

Installation of this device has to be carried out by a qualified mechanic / installer.

For detailed explanation see "EU-Declaration of conformity" on the last page of this manual

Transmitter type and options	Equipment category	Ambient temperature range
Temperature Transmitter type TT-2000 With transparent indicator cover (Option I)	II 1G	-20°C till 70°C Process temperature range: -20 °C to +100 °C
Temperature Transmitter type TT-2000 With closed cover	II 3G	-20°C till 70°C Process temperature range: -20 °C to +100 °C
Temperature Transmitter type TT-2000 With Option G100	II 1G and II 2D	-20°C till 70°C Process temperature range: -20 °C to +100 °C

The maximum surface temperature of IP6x enclosure T100°C is based on a maximum ambient temperature of 70°C. This temperature is determined with a dust layer of maximum 5 mm.

Electrical data for Ex transmitters

Supply/output circuit (terminals 3 '-' and 4 '+'): in type of protection intrinsic safety Ex ia IIC, or Ex ia IIIC only for connection to a certified intrinsically safe circuit, with the following maximum values: $U_i = 26,5$ Vdc; $I_i = 110$ mA; $P_i = 0,9$ W (linear source); $L_i = 1,4$ mH; $C_i = 63$ nF (without cable between terminals 3 '-' and 4 '+').

Special Instructions

For use in a potentially explosive atmosphere caused by air/dust mixtures the following should be taken into consideration:

- the dust layer may not exceed a thickness of 5 mm
- as standard a transmitter is supplied with a certified cable gland (PG9). When using a different gland make sure it is certified.
- always use the covers supplied by Klay Instruments B.V.

All certifications are in compliance with IECEx scheme rules, and the International Standards:

EN IEC 60079-0:2018, EN 60079-11:2012, IEC 60079-7:2015/ A1:2017, IEC 60079-11:2011 and

IEC 17050-1:2010. The transmitters are certified for use in hazardous areas by DEKRA Certification.

4.5 TRACEBILITY YEAR OF MANUFACTURING

The year of manufacturing of the transmitter can be traced as follows: take the first two numbers from the serial number that is engraved in the transmitter and add 1970 to it. For example: if the 3902123. The year of manufacturing is 1970 + 39 = 2009.

4.6 SOFTWARE REVISIONS

Due to the improvements on the Series TT-2000, there are several software versions (revisions). For this reason it is possible the temperature transmitter you are working with does not support some options, which are discussed in this manual. Ask Klay Instruments BV.

5 FUNCTIONS OF PUSH BUTTONS

The Series TT-2000 can be programmed easily by use of the 3 front panel pushbuttons (See picture right).

The display can show engineering units of: mH₂O, inH₂O, bar and PSI.

The functions of the three pushbuttons will be explained below.

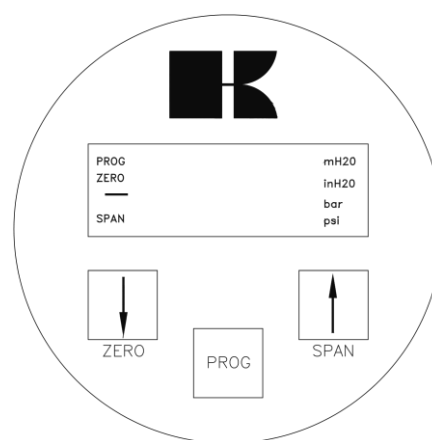

This button has 2 functions:

1. It can be directly used for adjusting the zero (zero / 4mA), with or without a test pressure. When the zero (4 mA) must be adjusted at 0 (atmospheric pressure), the button must be held until the word "ZERO" appears on the display. The transmitter is now set to 4 mA.
Note: test temperature should be 0°C.
2. Also, this button must be used for stepping down in the programming menu or to decrease a value (-).



This button has 2 functions:

1. It can be directly used for adjusting the span (20 mA), when using a test pressure (air). When a test pressure (50 °C) is supplied to the transmitter, the button must be held until the word "SPAN" appears on the display. The transmitter is adjusted at 0-50°C now.
2. Also, this button must be used for stepping up in the programming or to increase a value (+).



This button has 2 functions:

1. It is used to adjust the 11 Programming Points (P101 to P111). Push it once and P100 is displayed, use the [↑] (SPAN) to step to P101 etc.
2. This button must also be used for confirming the adjustments (enter).

6. PROGRAMMING POINTS (P101 – P110)

The following points can be adjusted by means of the three push buttons. For an explanation of these points see the next pages of this manual.

To change one of these points you have to push on [PROG] until "100" appears on the display. To go to from a lower program (P101) to a higher one (P102), push on button [↑] (SPAN).

To confirm the adjustments you always have to press on [PROG].

*) Standard adjustments ex works.

Programming points:	
P101	Zero adjustment (4 mA)
P102	Span adjustment (20 mA)
P103	Corrections Read Out Temperature
P104	Adjustment temperature unit on display (See Conversion table)
P105	4-20 mA *) 20-4 mA (Reverse output)
P106	Adjustment damping (0 tot 25 sec)
P107	Indication of process temp. (Read out on display)
P108	Read out on display: Curr (0) = current (4 - 20 mA) Unit (1) = pressure unit (*) (see conversion table) PerC (2) = percentages TenP (3) = ambient temperature
P109	Simulation of current
P110	HART Lo.Pr.= Local Protection (OFF/ON) Co.Pr.= Com. Protection (OFF/ON)

7. READING ON THE DISPLAY

On the standard built-in display several values can be shown.

During the programming of the temperature transmitter the display shows all the information that is needed.

PROG	mH20
ZERO	inH20
—	bar
SPAN	psi

When the transmitter is in the process the display gives all the information of the process temperature.

On the display the following units can be shown: mA, percentages or in temperature (see also P108).

N.B.: The standard temperature TT-2000 transmitter is supplied with two "closed" covers shielding the buttons and the display. As an option an "open" cover (IP 65) can be fitted. The display can then be used as a local process display. (Option: "I" extra price).

8. EXPLANATION PROGRAMMING POINTS P101 to P112

P101 ZERO ADJUSTMENT (4 mA)

The TT-2000 as standard is adjusted at 0°C to 4.00 mA.
It is also possible to adjust a zero-suppression or elevation.

For example: zero elevation of +10°C.

1. Push at [PROG] until "100" is shown on the display.
2. Push once at [↑] / SPAN till "101".
3. Confirm this by pushing [PROG].
4. Now the display will show 0.00 and "zero". Push at [↑] till 10.00 is on the display.
5. Confirm with [PROG].
6. The transmitter will automatically return to the set reading.

At a temperature of + 10°C is 4.00 mA output.

Note: the measured value is not 4.00 mA at room temperature.

This depends on the temperature display (see P112) and the set range.

The elevation can be canceled by pushing at [ZERO] till zero disappears out of the display.

P102 SPAN ADJUSTMENT (20 mA) WITHOUT TEST TEMPERATURE

Before adjusting the span take care the right temperature unit is selected.
(See also P104 and P108).

Example: Adjustment of the span at 0 –100°C.

First off all, the temperature unit must be adjusted at "degr. C". (See P104 and P108).

1. Push [PROG] till "100" is shown on the display.
2. Push twice at [↑] / SPAN until "102" is on the display.
3. Confirm this by pushing [PROG].
4. Push [SPAN] (+) or [ZERO] (-) to select the measuring range that is required.
5. Confirm by pushing [PROG].
The TT-2000 is adjusted now.

Note.: P102 is the adjustment of the total span.

When a "compound" range must be adjusted (for example -30 till +70°C), a span of 100 °C must be programmed. At P101 (ZERO,4 mA), -30°C must be adjusted. Now the transmitter is adjusted at: - 30°C = 4 mA and +70° C = 20 mA.

P103 CORRECTIONS READOUT TEMPERATURE

This feature can be used for the readout of the temperature transmitter to correct (Please do not use the feature, contact Klay Instruments')

1. ESC: Nothing can be changed.
Leave without doing anything (confirm with PROG).

P104 ADJUSTMENT TEMPERATURE UNIT ON DISPLAY (See Conversion table)

Several engineering units can be shown on the display by using a conversion factor. (See conversion table below). As standard the read out from TT-2000 is set to 'Degr' (degrees C).

To change this setting, the following acts are to be performed:

1. Push at [PROG] till "100" is shown on the display.
2. Push 4 times at [↑], go to [P104].
3. Push at [PROG] to confirm this.
4. Push at [↑] / [SPAN] (+) and set it to Fahr (See conversion table below).
5. Push [PROG] to confirm.

The transmitter will now read out in 'Fahr'

For correct conversion between both temperature scales the following conversion calculation must be used.

Celsius to Fahrenheit	$^{\circ}\text{C} = (^{\circ}\text{F} - 32) \times \frac{5}{9}$
Fahrenheit to Celsius	$^{\circ}\text{F} = ^{\circ}\text{C} \times \frac{9}{5} + 32$

*) When the value of the highest range is larger than 9999, "NA" will appear in the display (Not Applicable). Another unit must be chosen.

P105 REVERSE OUTPUT (20 - 4 mA or 4-20 mA)

The transmitter as standard is adjusted to 4-20 mA.

Push on [PROG] and go to P105.

Push once at [↑] to change the output to 20-4 mA (Reverse output).

Push at [PROG] to confirm this.

P106 ADJUSTMENT DAMPING (0 till 25 sec.)

In P106 an electronic damping can be adjusted between 0 and 25 seconds.

This can be done with the push buttons [↑] (up) and [↓] (down).

Always confirm by pushing once at [PROG].

P107 INDICATION OF AMBIENT TEMPERATURE (READ OUT ON DISPLAY)

1. Push [PROG] until "100" is shown on the display.
2. Push 7 times at [↑], go to [P107].
3. Push [PROG] to confirm this. Now the ambient temperature appears on the display (Indication: +/-2°C).

This will remain on the display. To get the actual ambient temperature back on the display you have to push again on P107 until the actual temperature appears on the display again.

P108 READ OUT ON DISPLAY

- Curr (0) = current (4 - 20 mA)
- Unit (1) = temperature unit (See conversion table)
- PERC (2) = percentages (0 - 100%)
- TENP (3) = ambient temperature (°C of °F)

As standard the transmitter is delivered with read out in units(1).

To change this, follow the next steps:

1. Push [PROG] until "100" is shown on the display.
2. Push 9 times at [↑] / SPAN till "108" appears on the display.
3. Confirm with [PROG].
4. Push once at [↑].
5. Push [PROG] to confirm this.

The transmitter will now read (°C or °F)

Also the read out can be 0 - 100%. In this case select "P108", option 2

P109

SIMULATION OF CURRENT (4-20 mA)

The transmitter can be used as a simulator of a current between 4 - 20 mA.

P110

WRITE PROTECTION

The Serie TT-2000 with HART-Protocol can be protected for writing (Write Protection). This is possible for two kinds of writings:

- Changes via the Display ("Lo.Pr" = Local Protection).
- Changes via external HART configuration software by the Hand-held terminal or the P.C. ("Co.Pr." = Communication Protection).

Standard, the transmitter is set to no-write protection.

Adjustment Local Protection:

1. Push [PROG] till "100" appears on the display.
2. Push [↑] / SPAN 11 times till "110" appears on the display.
3. Push [PROG] to confirm. ("Lo.Pr." appears on the display).
4. Push [↑]/[↓] for adjusting to "ON" or "OFF".
5. Push [PROG] to confirm.

Adjustment Communication Protection:

1. Push [PROG] till "100" appears on the display.
2. Push [↑] / SPAN 11 times till "110" appears on the display.
3. Push [PROG] to confirm. ("Lo.Pr." appears on the display).
4. Push once more at [PROG]. ("Co.Pr." appears on the display).
5. Push [↑]/[↓] for adjusting to "ON" or "OFF".
6. Push [PROG] to confirm.

N.B. When Lo.Pr. is set to "ON", the display shows the adjusted values of the parameters. Afterwards "PROT" (Protected) is shown.

P111

SERVICE MENU

Use only under order of manufacturer.

P112

SERVICE MENU

Use only under order of manufacturer.

9. PRECAUTIONS and WARNINGS:

- ✓ **Check if the specifications of the transmitter meet the needs of the process conditions**
- ✓ **Never once read the entire circumference**
- ✓ **As soon as the wiring is brought inside through the PG cable gland and connected to the terminal board, make sure the cable gland is tightly fixed, so that moisture cannot enter into the electronic housing.**
- ✓ **Avoid high pressure water-jets pointed at the venting.**
- ✓ **If the ambient conditions are very wet, we advise to use a venting through the cable. A special vented cable can be delivered on request. (The normal venting will be removed)**
- ✓ **The covers must be fully engaged, so that moisture cannot ingress into the electronic housing.
The covers must only be capable of being released or removed with the aid of a tool.**
- ✓ **WARRANTY: The warranty is 1 year from delivery date.
Klay Instruments B.V. does not accept liability for consequential damage of any kind due to use or misuse of the TT-2000. Warranty will be given, to be decided by the manufacturer. Transmitter must be shipped prepaid to the factory on manufacturers authorization.**
- ✓ **NOTE: Klay Instruments B.V. reserves the right to change its specifications at any time, without notice. Klay Instruments B.V. is not an expert in the customer's process (technical field) and therefore does not warrant the suitability of its product for the application selected by the customer.**

Manufactured by





 **KLAY-INSTRUMENTS**

www.klay-instruments.com

Nijverheidsweg 5
P.O. Box 13
Tel. +31-521-591550
Fax +31-521-592046

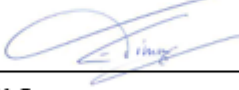
7991 CZ Dwingeloo
7990 AA Dwingeloo
The Netherlands
Email: info@klay.nl

Attachment: EU-Declaration of conformity

<p>EU-DECLARATION OF CONFORMITY</p> <p>KLAY-INSTRUMENTS</p> <p>Klay Instruments B.V. Nijverheidsweg 5, 7991 CZ Dwingeloo, The Netherlands</p> <p>Certify that the equipment intended for use in potentially explosive atmospheres, only new products, indicated here after:</p> <p style="text-align: center;">Electronic Pressure / Level Transmitter Series 2000, Series 2000-SAN, Series 2000-Cable, Series 2000-SAN-Cable, Series CER-2000 and Series 2000-Hydrobar-Cable, Series 2000-Hydrobar-EXTD, Temperature Transmitter Type TT-2000 and Pressure / Level Transmitter Hydrobar-I-Cable.</p> <p>Are in accordance with:</p> <ul style="list-style-type: none"> • Directive 2014/34/EU (Equipment and protective systems for use in potentially explosive atmospheres) • Directive 2014/30/EU (Electro Magnetic Compatibility). • Harmonized standards: <ul style="list-style-type: none"> ○ EN 60079-0: 2018 (General rules) ○ EN 60079-7: 2015/ A1:2018 (Equipment protection by increased safety "e") ○ EN 60079-11: 2012 (Equipment protection by intrinsic safety "I") ○ EN 60079-26: 2015 (Equipment with Equipment Protection Level (EPL) Ga) ○ EN 61000-6-2: 2001 (EMC, Immunity in industrial location) ○ EN 61000-6-3: 2001 (EMC, Emission in industrial location) ○ EN 61000-6-4: 2001 (EMC, Emission in industrial location) ○ EN-ISO-IEC 80079-34: 2011 (Potentially explosive atmospheres – Application of quality systems) • The type (protection mode Intrinsic Safety "ia" and Non-sparking "e") which has been the subject of, EC-type Examination, Certificate Number: ATEX-DEKRA 20ATEX0025 X and ATEX-DEKRA 20ATEX0026 X Delivered by the DEKRA, Meander 1051, 6825 MJ Arnhem, The Netherlands, Notified Body No. 0344 <p>Manufacturing plant in Dwingeloo which has been the subject of; Production Quality Assurance, Notification Number: DEKRA 12ATEXQ0041, Issue 3 Delivered by the DEKRA, Meander 1051, 6825 MJ Arnhem, The Netherlands, Notified Body No. 0344</p>	
<p>Date: January 21st, 2020. Signature: </p> <p>E. Timmer Managing Director – Klay Instruments B.V.</p>	
	<p>The marking of the equipment for gas group for use in zone 0: II 1 G Ex ia IIC T4 Ga</p>
	<p>The marking of the equipment for dust group for use in zone 1: II 2 D Ex ib IIIC T100°C Db</p>
	<p>The marking of equipment for gas group for use in zone 2. II 3 G Ex ec IIC T4 Gc</p>
<p>II equipment for use in industries above ground (and not in mines endangered by firedamp). 1 equipment for use in Zone 0 (if G), Zone 20 (if D) 2 equipment for use in Zone 1 (if D), Zone 20 (if D) 3 equipment for use in Zone 2 G equipment for use with gas, vapours or mists D equipment for use with dust Ex equipment in compliance with European standards for explosive atmospheres ia equipment in compliance with specific building rules for intrinsically safe equipment ec equipment in compliance with specific building rules for non-sparking safe equipment IIC equipment for use with gas of subdivision C IIIC equipment for use in places with conductive dust. T4 equipment whose surface temperature does not exceed 135°C with < 70°C Ambient temperature. T100°C maximum surface temperature of the equipment covered with a dust layer of 5 mm</p>	
<p>Ingress Protection Grade, Series 2000, 2000-SAN, CER-2000: IP 66 Ingress Protection Grade, Series 2000-Hydrobar-Cable and 2000-Hydrobar-EXTD: IP 66 The Hydrobar-I-Cable and all other submersible parts from the Series 2000-Hydrobar, 2000-Cable and 2000-SAN-Cable are IP 68. Furthermore, whatever the protection mode, only use cable glands with a protection degree of at least IP 66. Be sure the cable diameter complies with the selected cable gland. Tighten the cable gland in a proper way. Never forget to mount the covers of the electronics housings in a proper way. For other technical details, refer to the instruction manuals of the transmitters.</p>	